

Kinghelm®

PIN NUMBER	SIGNAL NAME
PIN 1	Vbus
PIN 2	D-
PIN 3	D+
PIN 4	GND
PIN 5	StdA_SSRX-
PIN 6	StdA_SSRX+
PIN 7	GND_DRAIN
PIN 8	StdA_SSTX-
PIN 9	StdA_SSTX+
SHELL	GND

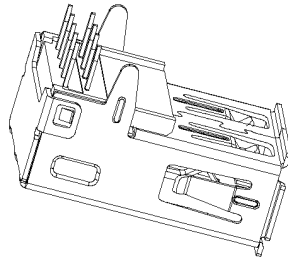

NOTES:

- MATERIAL:
 - HOUSING: PBT ,COLOR IS BLUE;
 - CONTACT: BRASS (H65 T=0.20&0.25mm);
 - SHELL: COLD ROLLED IRON (SPCC T=0.30mm);
- ELECTRICAL:
 - VOLTAGE RATING: 30V DC ;
 - CURRENT RATING: 1.5A ;
 - CONTACT RESISTANCE: 30MILLIOHMS MAX.;
 - WITHSTAND VOLTAGE: 100V AC RMS 50(60)Hz,1MIN.;
 - INSULATION RESISTANCE: 100MEGOHMS MIN @500V DC;
- MECHANICAL:
 - MATING FORCE: 35N MAX.;
 - UNMATING FORCE: 5~35N ;
 - OPERATING LIFE: 1500 CYCLES MIN.;
- PLATING:
 - TERMINAL:
 - NI PLATING OVER ALL,
 - Tin PLATING ON SOLDER AREA,
 - Au G/Fu" ON CONTACT AREA;
 - SHELL: NI PLATING OVER ALL;
- ENVIRONMENTAL:
 - STORAGE TEMPERATURE RANGE: -40°C~+85°C;
 - OPERATION TEMPERATURE RANGE: -25°C~+70°C;

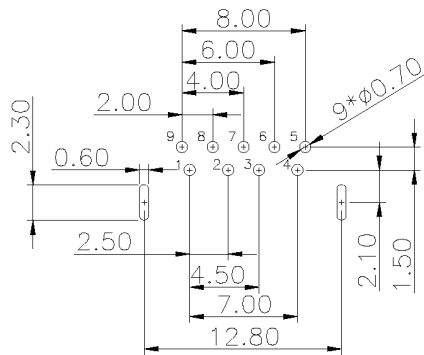
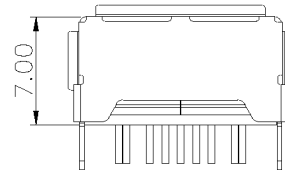
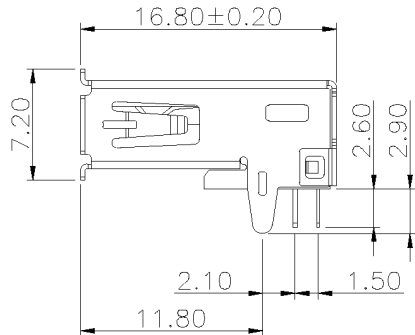
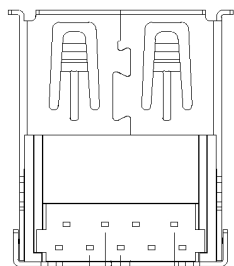
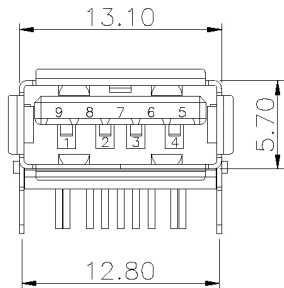
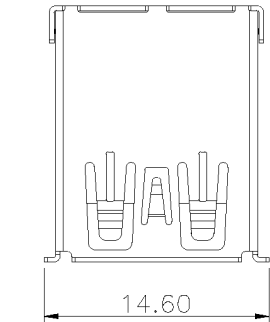

RECOMMENDER P.C.B. LAYOUT TOP VIEW
(COMPONENT SIDE TOLERANCE ±0.05)

深圳市金航标电子有限公司		WWW.BDS666.COM		
KH-3.0AF90ZJ-16.8JB		0775-83044319		
UNLESS OTHERWISE, GENERAL TOLERANCE: X.xxx ±0.10 X.xx ±0.20 X.x ±0.30	NAME: 3.0 A母90° 直脚有边		P/N: 09.03.02.003	
	THIRD ANGLE PROJECTION		UNIT: MM	SCALE 1:1
ANGULAR: X.xx° ±1° X.x° ±3° X.° ±5°	DRAWN:		CHECKED:	APPROVED:
		SIZE: A4	SHEET: 1/1	REV. A1