

SECTION A-A
Without cover

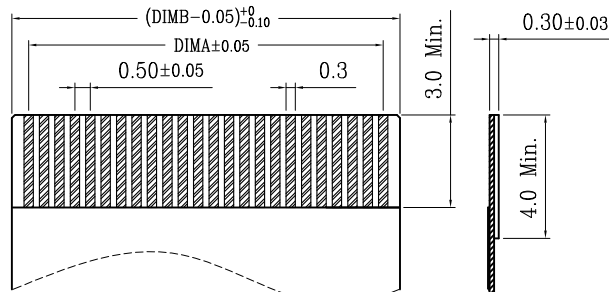
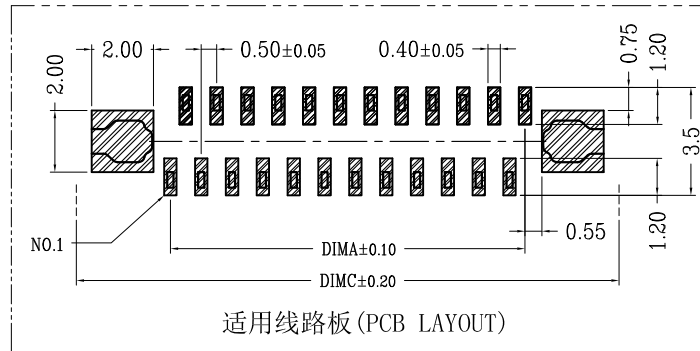
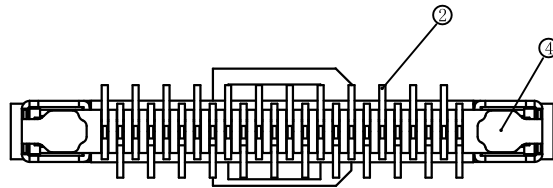
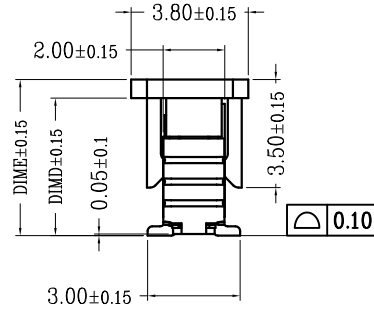
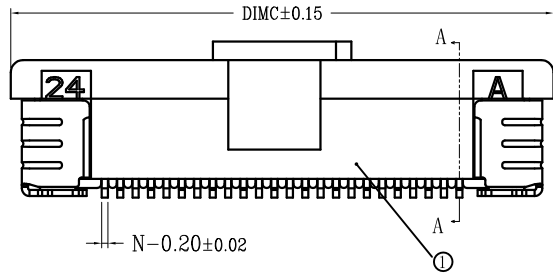
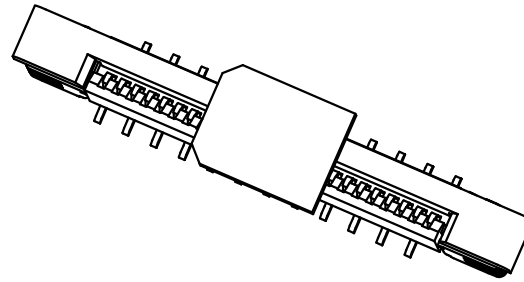

适用扁平线 (Applicable Flat Cable)

版次	变更摘要	日期
1	增加料号说明	2015/1/28

序号	品名	材质
①	0.5拉拔3代胶芯 (H2.0)	LCP UL94V-0 本色
②	0.5拉拔立式端子	铜合金/表面镀锡
③	0.5拉拔卧式3代后盖	LCP UL94V-0 黑色
④	0.5拉拔3代焊片 (H2.0)	铜合金/表面镀锡
⑤	0.5拉拔立式3代吸盖	LCP UL94V-0 黑色

CKT	DIM A	DIM B	DIM C	DIM D	DIM E
6	2.50	3.56	8.60		
7	3.00	4.06	9.10		
8	3.50	4.56	9.60		
9	4.00	5.06	10.10		
10	4.50	5.56	10.60		
11	5.00	6.06	11.10		
12	5.50	6.56	11.60		
13	6.00	7.06	12.10		
14	6.50	7.56	12.60		
15	7.00	8.06	13.10		
16	7.50	8.56	13.60		
17	8.00	9.06	14.10		
18	8.50	9.56	14.60		
19	9.00	10.06	15.10		
20	9.50	10.56	15.60	4.45	5.05
21	10.00	11.06	16.10		
22	10.50	11.56	16.60		
23	11.00	12.06	17.10		
24	11.50	12.56	17.60		
25	12.00	13.06	18.10		
26	12.50	13.56	18.60		
27	13.00	14.06	19.10		
28	13.50	14.56	19.60		
29	14.00	15.06	20.10		
30	14.50	15.56	20.60		
31	15.00	16.06	21.10		
32	15.50	16.56	21.60		
33	16.00	17.06	22.10		
34	16.50	17.56	22.60		

技术指标:

1. 塑件表面应光洁、无毛边、无明显收缩、缺陷、裂纹等现象。
2. 温度范围: -25° C~85° C.
3. 额定电压: 50V, AC/DC(等效).
4. 接触电阻: ≤0.03Ω.
5. 绝缘电阻: ≥500MΩ
6. 产品料号:



一般公差 (TOLERANCE)
 X ±0.50 XX ±1.0
 X ±0.20 XXX ±0.05
 ANGLES ±1°

深圳市金航标电子有限公司		www.kinghelm.com.cn	
KH-FPC0.5-H5.0-18P-LTQB		0755-28190160	
品名 (TITLE) 0.5 Pitch 拉拔立式3代正脚位1代		制图 (DR) Anlan	
料号 (DWG.NO) FP218H-0xxS10M		校对 (CHKD) 王涛	
比例 (SCALE) 1:1		审核 (APPD) 黄志明	
单位 (UNITS) mm	张数 (SHEET) 1 OF 2	SIZE A4	REV A